

[POWER COMMANDER V]

2009 Kawasaki Versys

Installation Instructions



PARTS LIST

- 1 Power Commander
- 1 USB Cable
- 1 CD-ROM
- 1 Installation Guide
- 2 Power Commander Decals
- 2 Dynojet Decals
- 2 Velcro
- 1 Alcohol swab

THE IGNITION MUST BE TURNED OFF BEFORE INSTALLATION!

YOU CAN ALSO DOWNLOAD THE POWER COMMANDER SOFTWARE AND LATEST MAPS FROM OUR WEB SITE AT:
www.powercommander.com

PLEASE READ ALL DIRECTIONS BEFORE STARTING INSTALLATION

Dynojet

2191 Mendenhall Drive North Las Vegas, NV 89081 (800) 992-4993 www.powercommander.com

POWER COMMANDER V INPUT ACCESSORY GUIDE

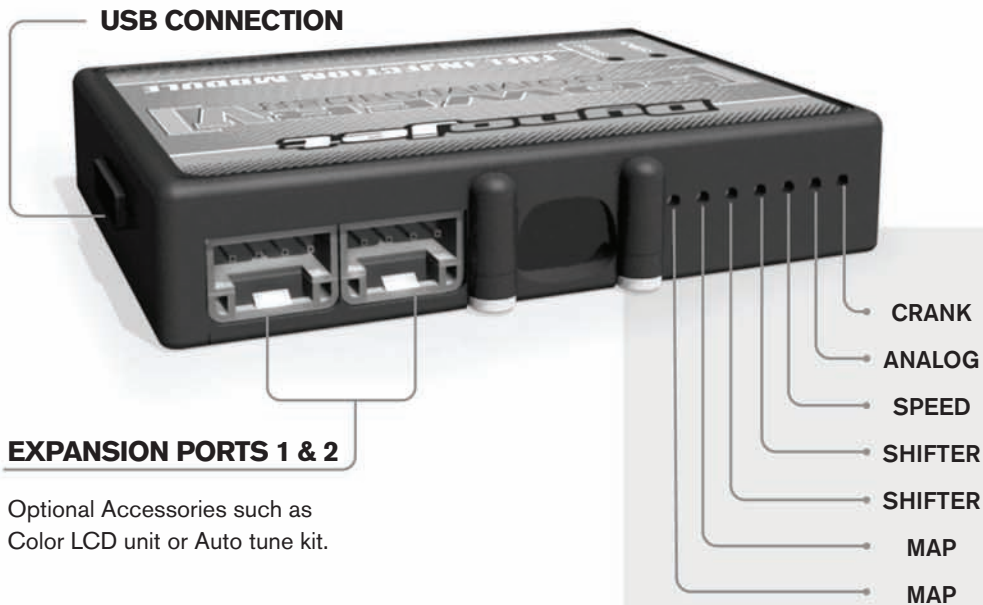

Optional Accessories such as Color LCD unit or Auto tune kit.

Wire connections:

To input wires into the PCV first remove the rubber plug on the backside of the unit and loosen the screw for the corresponding input. Using a 22-24 gauge wire strip about 10mm from its end. Push the wire into the hole of the PCV until it stops and then tighten the screw. Make sure to reinstall the rubber plug.

NOTE: If you tin the wires with solder it will make inserting them easier.

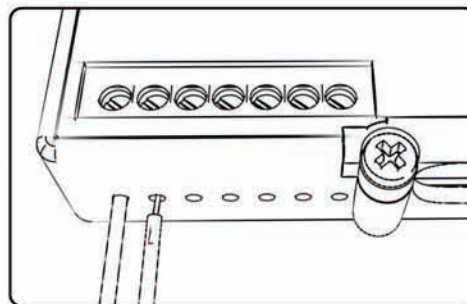

ACCESSORY INPUTS

Map -

The PCV has the ability to hold 2 different base maps. You can switch on the fly between these two base maps when you hook up a switch to the MAP inputs. You can use any open/close type switch. The polarity of the wires is not important. When using the Autotune kit one position will hold a base map and the other position will let you activate the learning mode. When the switch is "CLOSED" Autotune will be activated.

Shifter-

These inputs are for use with the Dynojet quickshifter. Insert the wires from the Dynojet quickshifter into the SHIFTER inputs. The polarity of the wires is not important.

Speed-

If your application has a speed sensor then you can tap into the signal side of the sensor and run a wire into this input. This will allow you to calculate gear position in the Control Center Software. Once gear position is setup you can alter your map based on gear position and setup gear dependent kill times when using a quickshifter.

Analog-

This input is for a 0-5v signal such as engine temp, boost, etc. Once this input is established you can alter your fuel curve based on this input in the control center software.

Crank-

Do **NOT** connect anything to this port unless instructed to do so by Dynojet. It is used to transfer crank trigger data from one module to another.

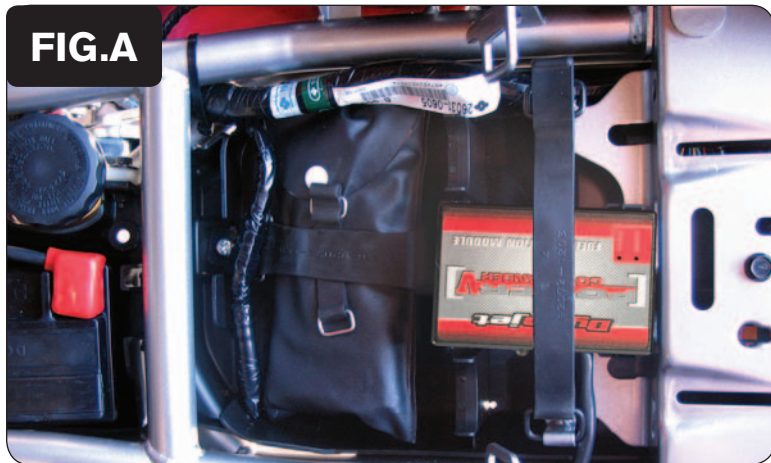

- 1 Remove the seat.
- 2 Remove the fuel tank.
- 3 Secure the PCV in the tail section using the stock band.
- 4 Route the PCV harness towards the front of the bike along the left hand side of the frame (Fig. A).

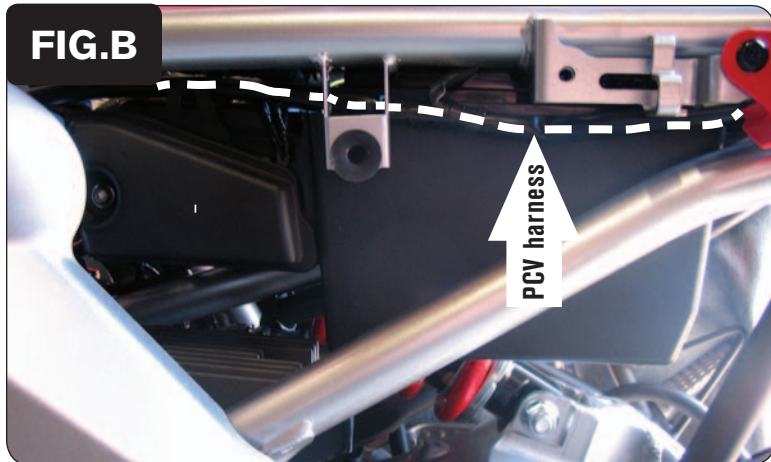

- 5 Route the PCV harness along the left hand side frame tube (Fig. B).

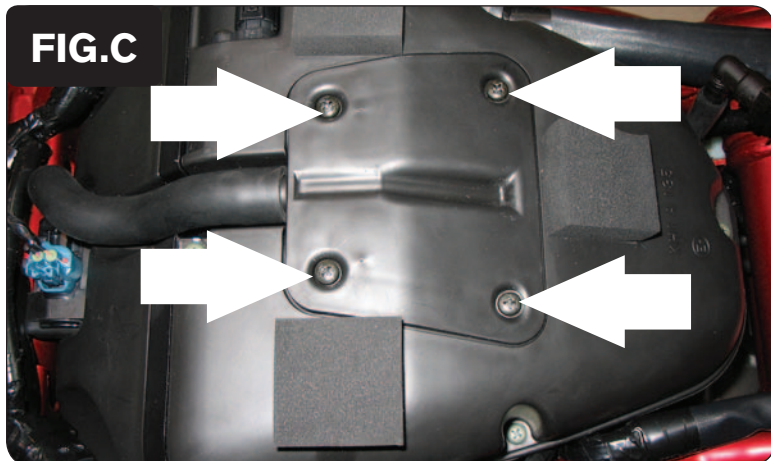

- 6 Remove the bolts in the air box lid (Fig. C).

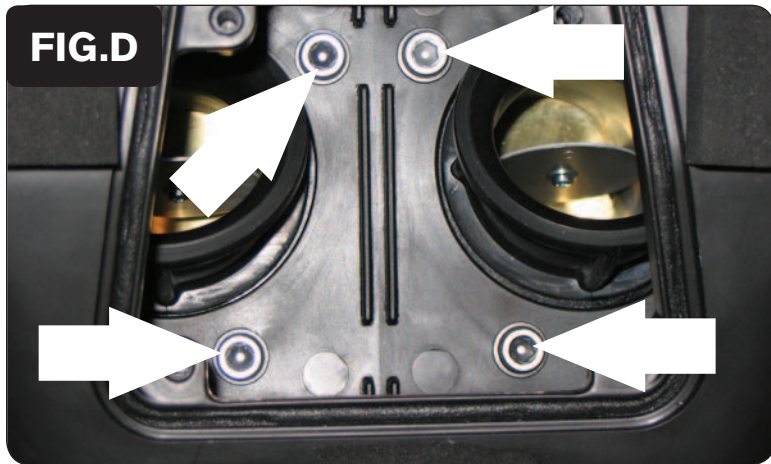

- 7 Remove the 4 bolts that hold the air box to the throttle bodies (Fig. D).
- 8 Disconnect the air box temp sensor and hoses leading to the air box.
- 9 Remove the air box from the bike.

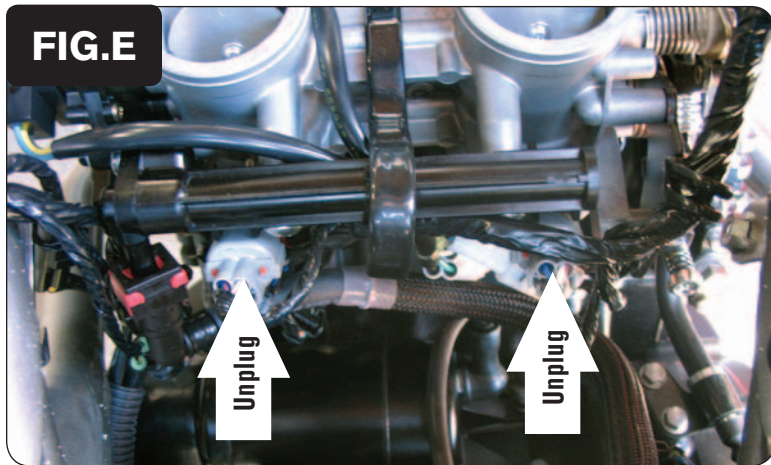

- 10 Unplug the stock wiring harness from the injectors (Fig. E).

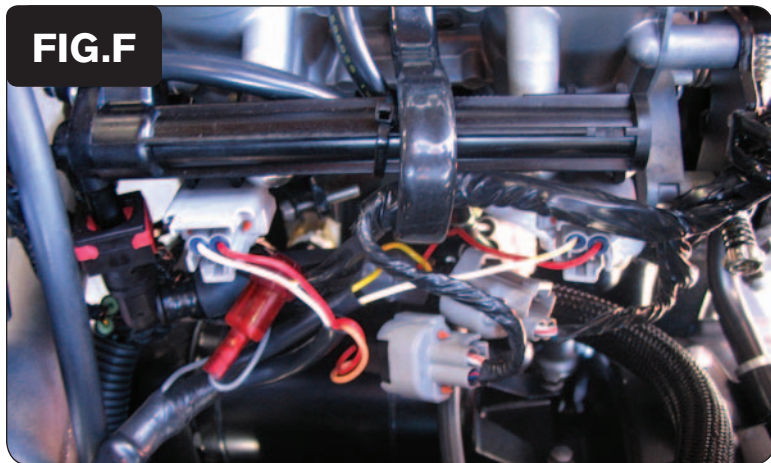

- 11 Plug the PCV connectors in-line of the stock wiring harness and fuel injector (Fig. F) for both cylinders
Connect the ORANGE colored wires of the PCV to the left hand cylinder.

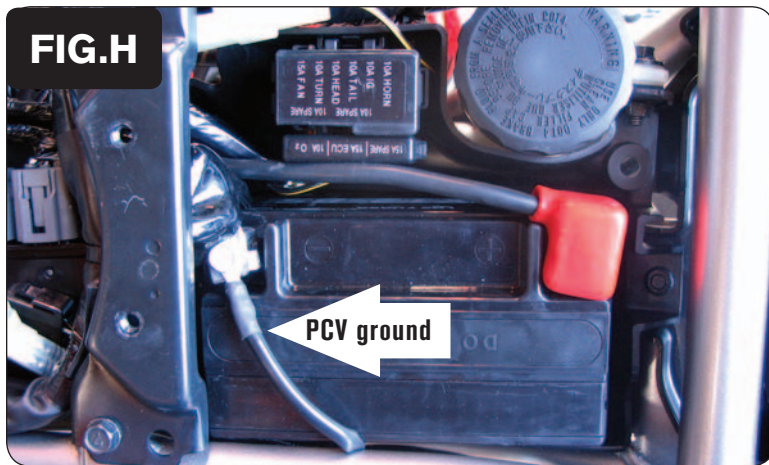
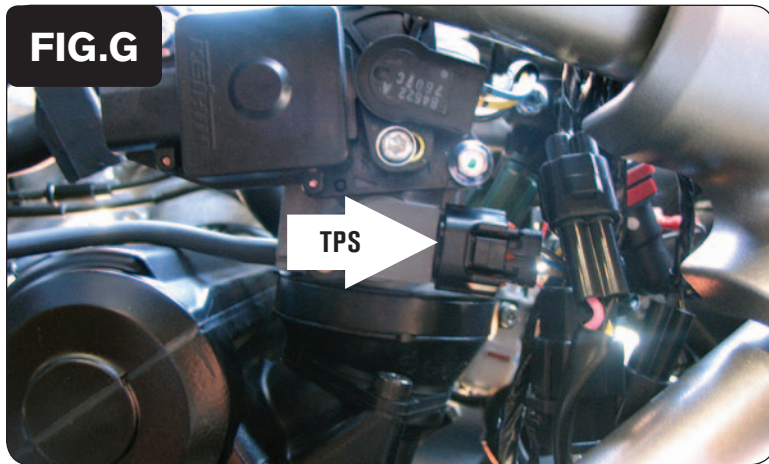

- 12 Locate the Throttle Position Sensor connector on the left hand side of the throttle bodies.
 - 13 Unplug the TPS connector from the throttle bodies and connect the PCV harness in-line of the TPS and stock wiring harness.
 - 14 Connect the ground wire from the PCV to the negative side of the battery (Fig. H).
 - 15 Reinstall the air box.
 - 16 Reinstall the fuel tank and seat.
- Speed input** - YELLOW wire of 3 pin BLACK connector from c/s sprocket (YEL-PINK-BLK)
- Temperature input** - ORANGE wire of cylinder temp sensor
- 12v source for Auto tune** - RED wire of 6 pin connector for tail light - under seat