

[POWER COMMANDER V]

2011 Suzuki GSXR600

Installation Instructions



PARTS LIST

- 1 Power Commander
- 1 USB Cable
- 1 CD-ROM
- 1 Installation Guide
- 2 Power Commander Decals
- 2 Dynojet Decals
- 2 Velcro
- 1 Alcohol swab
- 1 O2 Optimizer

THE IGNITION MUST BE TURNED OFF BEFORE INSTALLATION!

YOU CAN ALSO DOWNLOAD THE POWER COMMANDER SOFTWARE AND LATEST MAPS FROM OUR WEB SITE AT:
www.powercommander.com

PLEASE READ ALL DIRECTIONS BEFORE STARTING INSTALLATION

Dynojet

2191 Mendenhall Drive North Las Vegas, NV 89081 (800) 992-4993 www.powercommander.com

POWER COMMANDER V INPUT ACCESSORY GUIDE

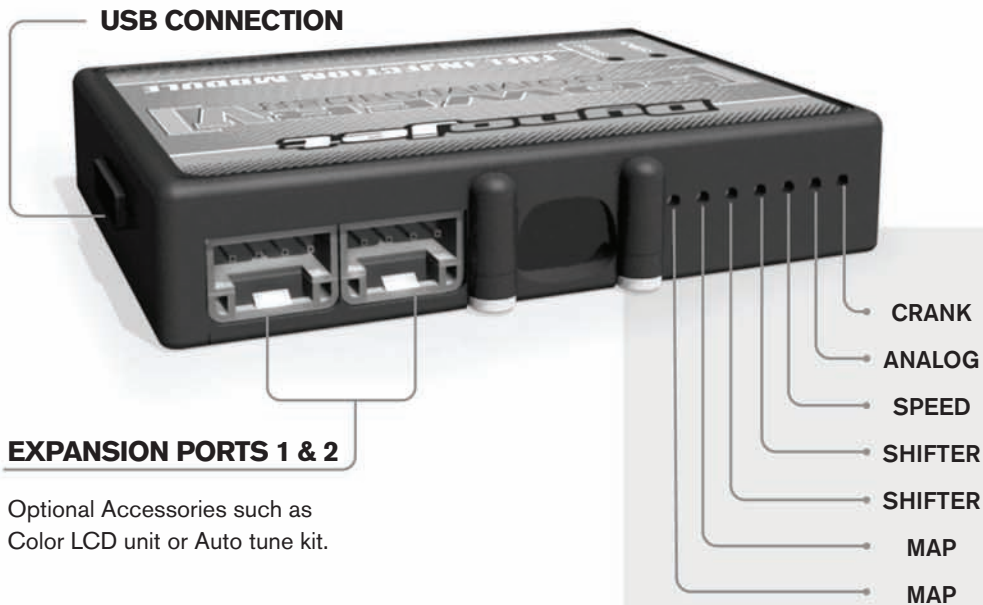

Optional Accessories such as Color LCD unit or Auto tune kit.

Wire connections:

To input wires into the PCV first remove the rubber plug on the backside of the unit and loosen the screw for the corresponding input. Using a 22-24 gauge wire strip about 10mm from its end. Push the wire into the hole of the PCV until it stops and then tighten the screw. Make sure to reinstall the rubber plug.

NOTE: If you tin the wires with solder it will make inserting them easier.

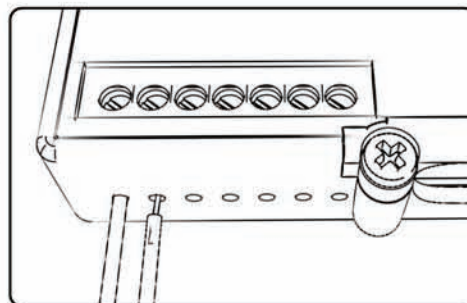

ACCESSORY INPUTS

Map -

The PCV has the ability to hold 2 different base maps. You can switch on the fly between these two base maps when you hook up a switch to the MAP inputs. You can use any open/close type switch. The polarity of the wires is not important. When using the Autotune kit one position will hold a base map and the other position will let you activate the learning mode. When the switch is "CLOSED" Autotune will be activated.

Shifter-

These inputs are for use with the Dynojet quickshifter. Insert the wires from the Dynojet quickshifter into the SHIFTER inputs. The polarity of the wires is not important.

Speed-

If your application has a speed sensor then you can tap into the signal side of the sensor and run a wire into this input. This will allow you to calculate gear position in the Control Center Software. Once gear position is setup you can alter your map based on gear position and setup gear dependent kill times when using a quickshifter.

Analog-

This input is for a 0-5v signal such as engine temp, boost, etc. Once this input is established you can alter your fuel curve based on this input in the control center software.

Crank-

Do **NOT** connect anything to this port unless instructed to do so by Dynojet. It is used to transfer crank trigger data from one module to another.

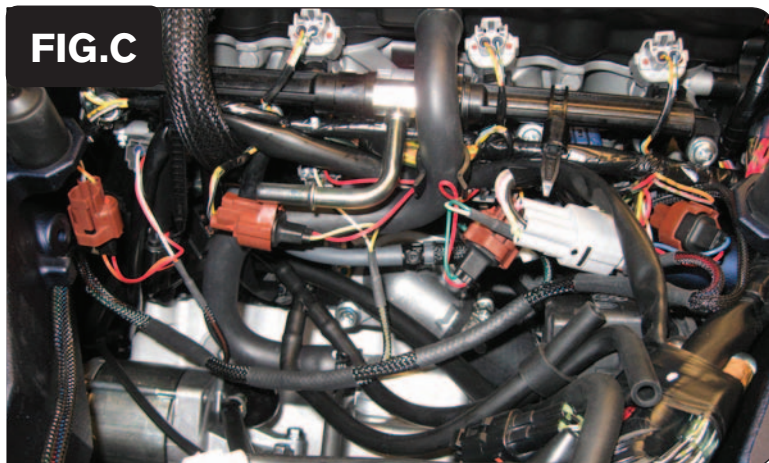
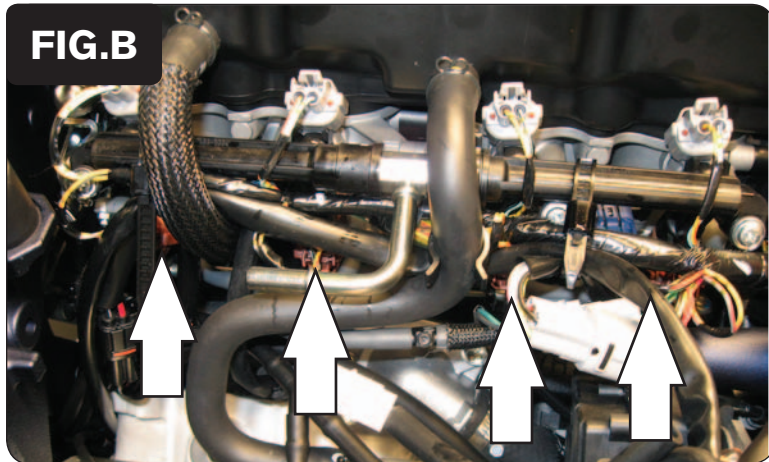
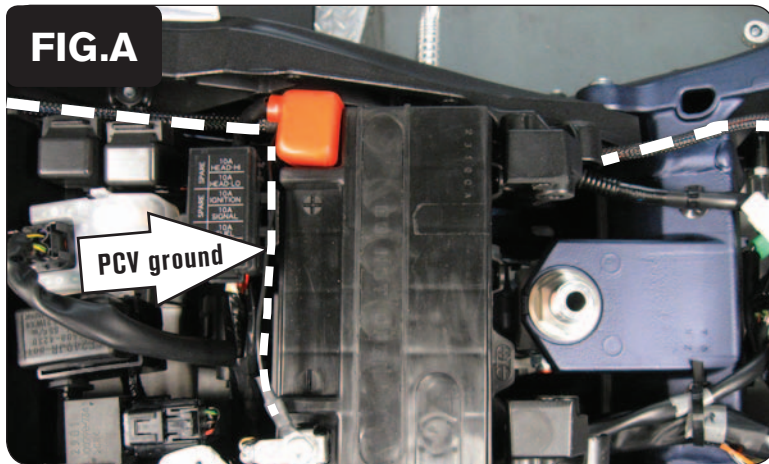

- 1 Remove the main seat and the passenger seat or solo cover.
- 2 Prop the fuel tank up using the prop rod in the tail section.
- 3 Lay the PCV in the tail section.
- 4 Route the wiring harness from the PCV under the tail section and go towards the engine down the left hand side of the bike.
- 5 Attach the ground wire from the PCV to the negative side of the battery (Fig. A).

- 6 Unplug the stock wiring harness from each of the LOWER injectors (Fig. B).
The lower injectors are much harder to access than the uppers. Using a set of needle nose pliers will aid in removing the connectors.
The lower injector connectors are BROWN

- 7 Plug the connectors from the PCV inline of the stock LOWER injectors and the stock wiring harness (Fig.C).

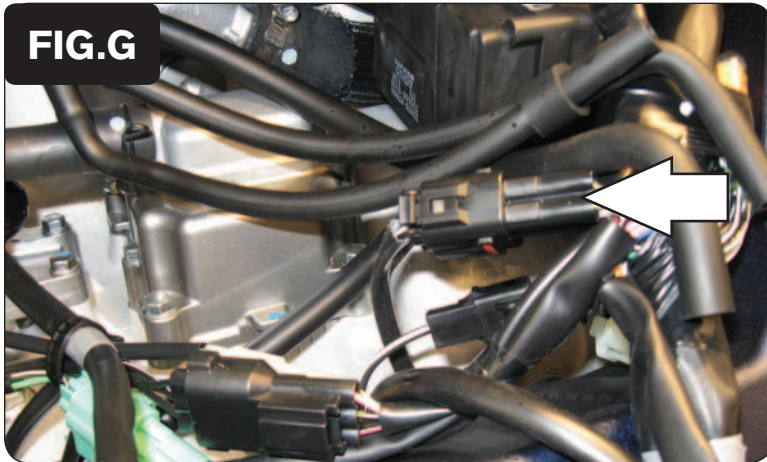

- 12 Locate where the stock O2 sensor connects to the main wiring harness. This is a BLACK 4 pin connector located under the fuel tank (Fig. G).
- 13 Unplug this connection and plug the Dynojet O2 eliminator into the main wiring harness.

The stock O2 sensor will not be connected to anything at this time.

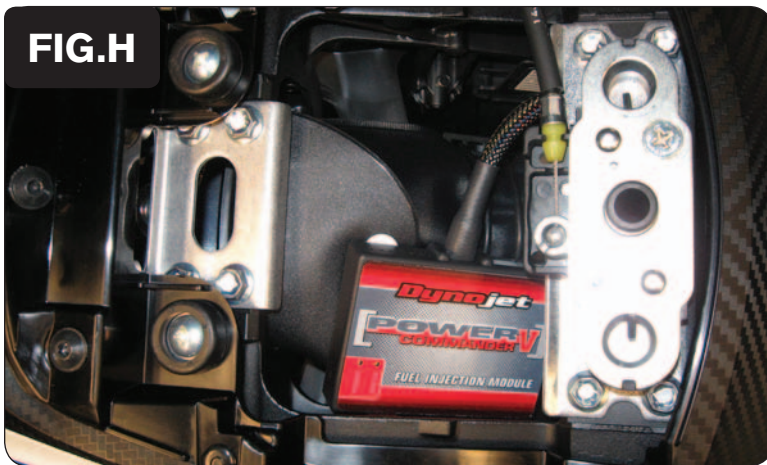

- 14 Install the PCV in the tail section.
- 15 Lower the fuel tank back into position making sure none of the wires get pinched or damaged.

Speed input location - PINK wire of sensor on sprocket cover.

Temperature input location - Green connector on back of cylinder. Use the BLK/BLEU wire.

12v for Autotune - Brown wire of tail light connector.