

[POWER COMMANDER V]

2009 Suzuki Gladius

Installation Instructions



PARTS LIST

- 1 Power Commander
- 1 USB Cable
- 1 CD-ROM
- 1 Installation Guide
- 2 Power Commander Decals
- 2 Dynojet Decals
- 2 Velcro
- 1 Alcohol swab

THE IGNITION MUST BE TURNED OFF BEFORE INSTALLATION!

YOU CAN ALSO DOWNLOAD THE POWER COMMANDER SOFTWARE AND LATEST MAPS FROM OUR WEB SITE AT:
www.powercommander.com

PLEASE READ ALL DIRECTIONS BEFORE STARTING INSTALLATION

Dynojet

2191 Mendenhall Drive North Las Vegas, NV 89081 (800) 992-4993 www.powercommander.com

POWER COMMANDER V INPUT ACCESSORY GUIDE

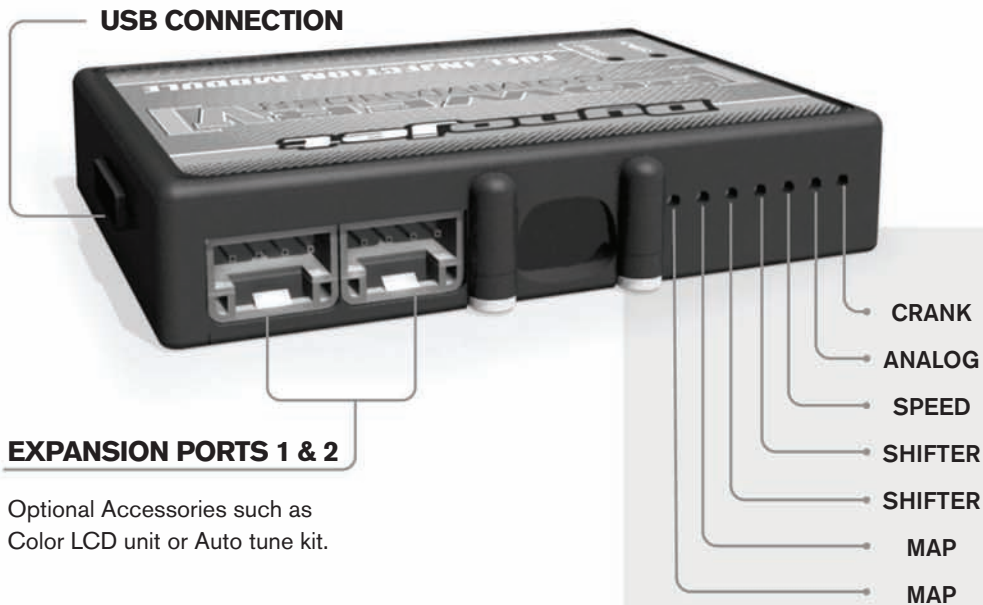

Wire connections:

To input wires into the PCV first remove the rubber plug on the backside of the unit and loosen the screw for the corresponding input. Using a 22-24 gauge wire strip about 10mm from its end. Push the wire into the hole of the PCV until it stops and then tighten the screw. Make sure to reinstall the rubber plug.

NOTE: If you tin the wires with solder it will make inserting them easier.

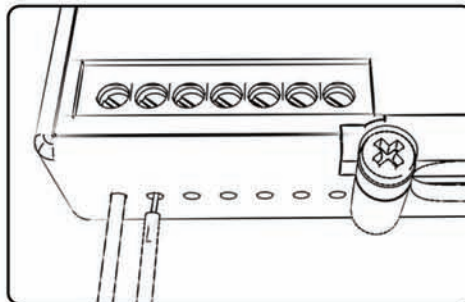

ACCESSORY INPUTS

Map -

The PCV has the ability to hold 2 different base maps. You can switch on the fly between these two base maps when you hook up a switch to the MAP inputs. You can use any open/close type switch. The polarity of the wires is not important. When using the Autotune kit one position will hold a base map and the other position will let you activate the learning mode. When the switch is "CLOSED" Autotune will be activated.

Shifter-

These inputs are for use with the Dynojet quickshifter. Insert the wires from the Dynojet quickshifter into the SHIFTER inputs. The polarity of the wires is not important.

Speed-

If your application has a speed sensor then you can tap into the signal side of the sensor and run a wire into this input. This will allow you to calculate gear position in the Control Center Software. Once gear position is setup you can alter your map based on gear position and setup gear dependent kill times when using a quickshifter.

Analog-

This input is for a 0-5v signal such as engine temp, boost, etc. Once this input is established you can alter your fuel curve based on this input in the control center software.

Crank-

Do **NOT** connect anything to this port unless instructed to do so by Dynojet. It is used to transfer crank trigger data from one module to another.



- 1 Remove the main seat and the passenger seat.
- 2 Install the PCV in the tail of the bike on top of the tool kit (Fig. A)

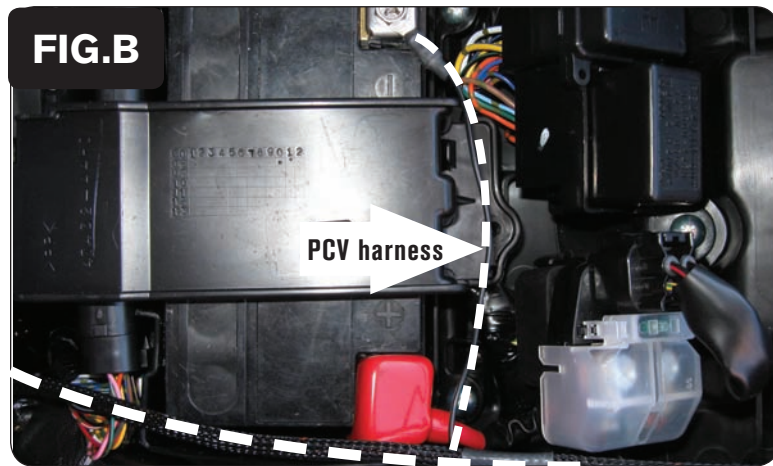

- 3 Route the wires from the PCV down the left side of the bike and go towards the engine.
- 4 Attach the ground wire of the PCV to the negative side of the battery (Fig. B)

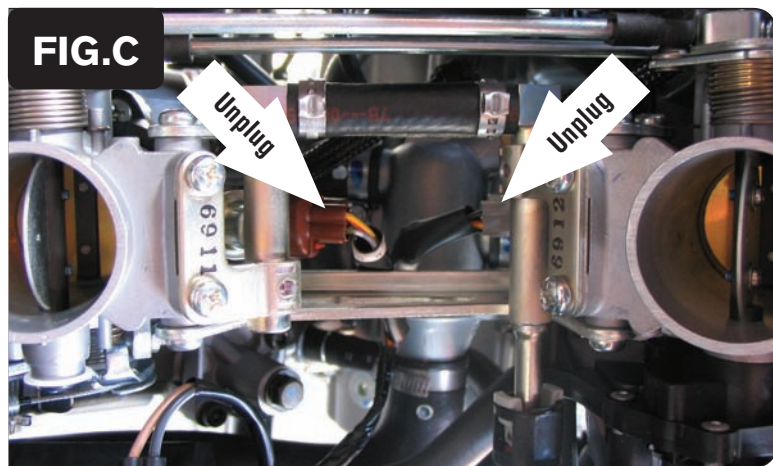

- 5 Prop the front of the fuel tank up using the Suzuki prop rod.
- 6 Remove the air box.
The airbox does need to be removed to perform this installation but may make it easier as the stock injector connectors can be very difficult to remove.
- 7 Locate the stock injector connectors. One is BROWN (frt cylinder) and one is GREY (rr cylinder). Unplug these connectors from the injectors.

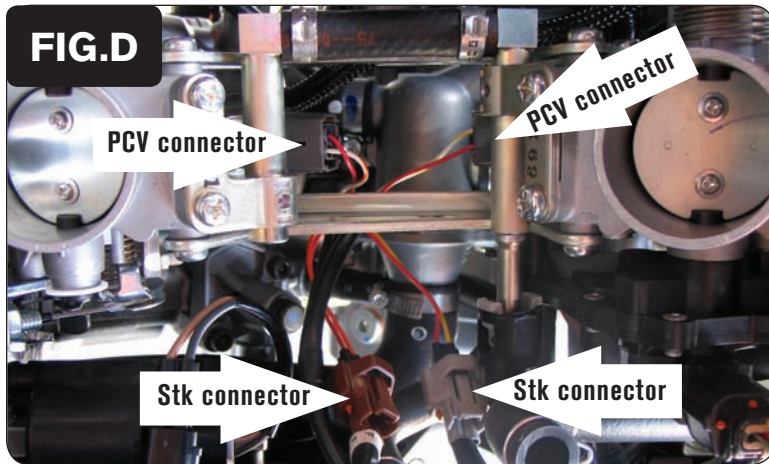

- 8 Plug the connectors from the PCV in-line of the stock wiring harness and the injectors (Fig. D).

Connect the ORANGE wires from the PCV to the front cylinder and stock BROWN connector.

Connect the YELLOW wires from the PCV to the rear cylinder and stock GREY connector.

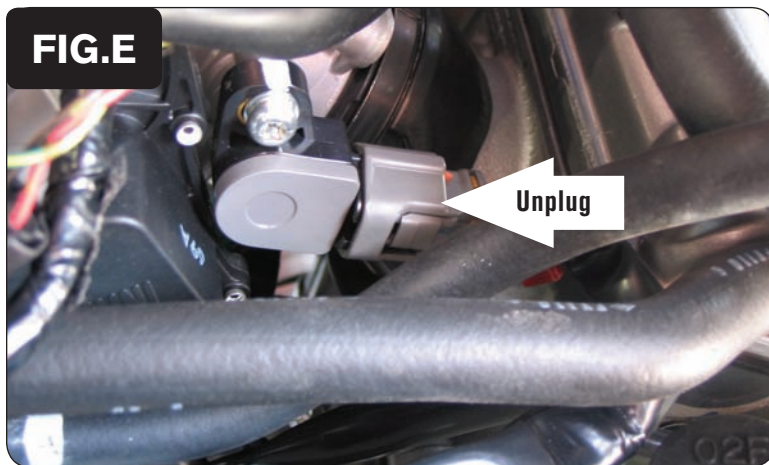

- 9 Locate the Throttle Position Sensor connector located on the left side of the throttle body.
- 10 Unplug the connector from the TPS (Fig. E).

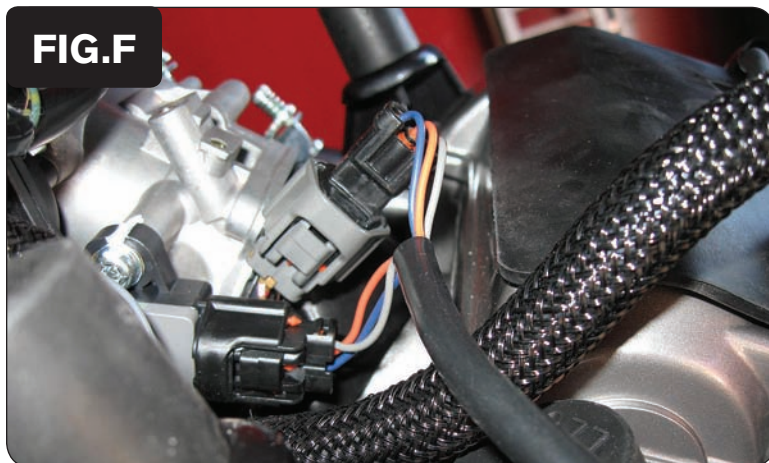

- 11 Plug the PCV connectors in-line of the stock wiring harness and TPS (Fig. F).

FIG.G

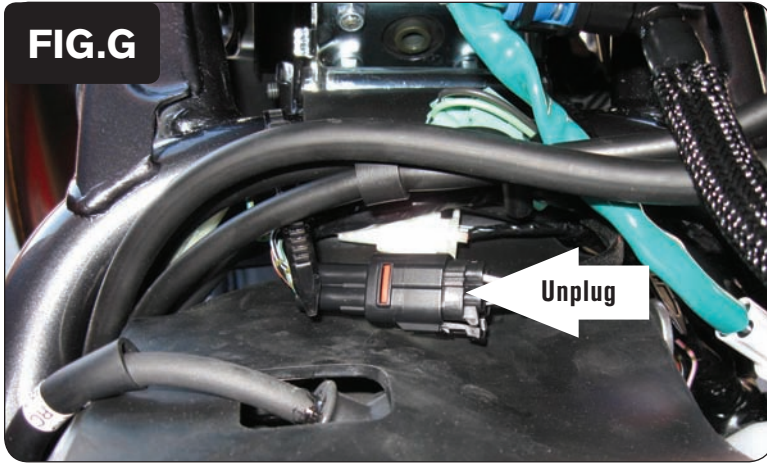
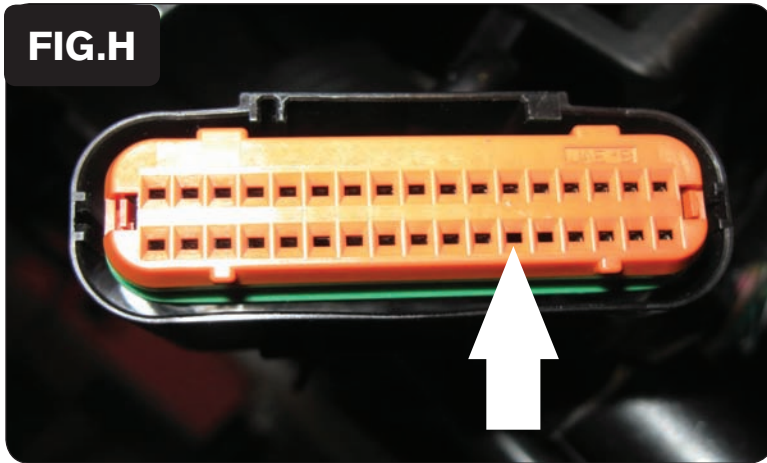

FIG.H



- 12 Locate the stock O2 sensor connection under the fuel tank (Fig. G).

This is a BLACK 4 pin connector.

- 13 Unplug this connection.

The stock O2 sensor will not be connected to anything at this time. It can be removed from the exhaust if you have a way to cap the bung.

- 14 To disable the FI light when the O2 sensor is unplugged remove the BLACK/BROWN wire of the ECU. This is pin #23 from the BLACK connector.

Remove the ORANGE retainer and then use a pick or very small screwdriver to release the tab inside the connector while pulling on the wire from the back side.

- 15 Reinstall the air box if it was removed. Reinstall the fuel tank.

Speed input - PINK/WHITE wire of 3 pin BLACK connector from speed sensor which is next to the coolant bottle under fuel tank.

Temperature input - BLUE/BLACK wire from cylinder temperature sensor under rear throttle body.