

[POWER COMMANDER V]

2009-2011 Triumph Street Triple

Installation Instructions



PARTS LIST

- 1 Power Commander
- 1 USB Cable
- 1 CD-ROM
- 1 Installation Guide
- 2 Power Commander Decals
- 2 Dynojet Decals
- 2 Velcro
- 1 Alcohol swab
- 1 O2 Optimizer

THE IGNITION MUST BE TURNED OFF BEFORE INSTALLATION!

YOU CAN ALSO DOWNLOAD THE
POWER COMMANDER SOFTWARE AND
LATEST MAPS FROM OUR WEB SITE AT:
www.powercommander.com

PLEASE READ ALL DIRECTIONS BEFORE STARTING INSTALLATION

Dynojet

2191 Mendenhall Drive North Las Vegas, NV 89081 (800) 992-4993 www.powercommander.com

POWER COMMANDER V INPUT ACCESSORY GUIDE

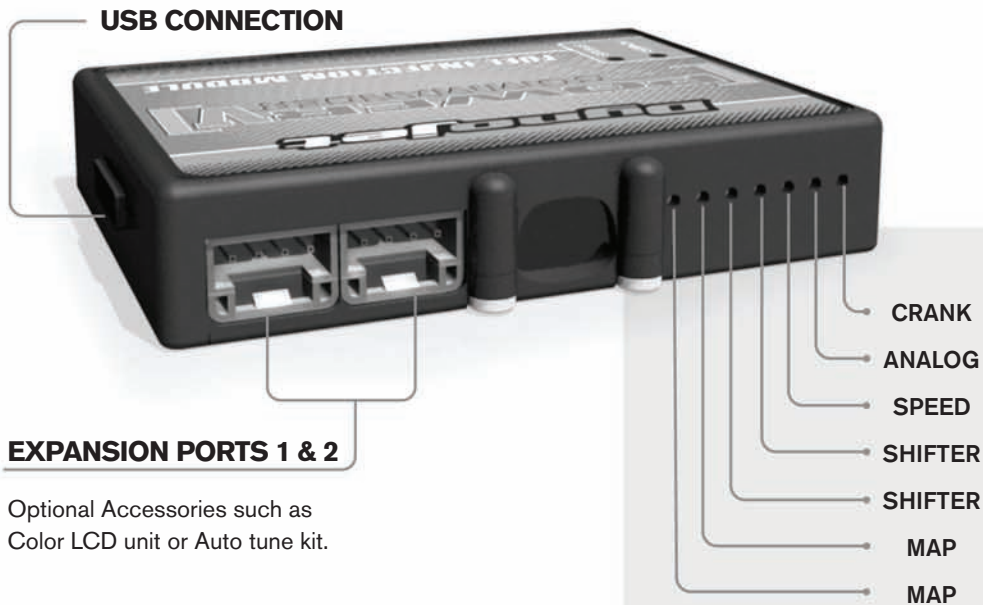

Wire connections:

To input wires into the PCV first remove the rubber plug on the backside of the unit and loosen the screw for the corresponding input. Using a 22-24 gauge wire strip about 10mm from its end. Push the wire into the hole of the PCV until it stops and then tighten the screw. Make sure to reinstall the rubber plug.

NOTE: If you tin the wires with solder it will make inserting them easier.

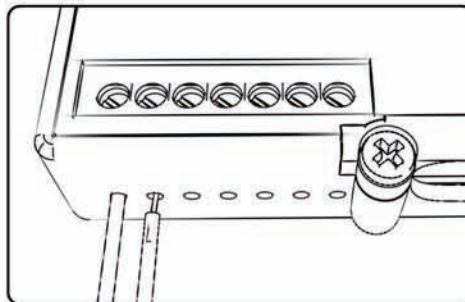

ACCESSORY INPUTS

Map -

The PCV has the ability to hold 2 different base maps. You can switch on the fly between these two base maps when you hook up a switch to the MAP inputs. You can use any open/close type switch. The polarity of the wires is not important. When using the Autotune kit one position will hold a base map and the other position will let you activate the learning mode. When the switch is "CLOSED" Autotune will be activated.

Shifter-

These inputs are for use with the Dynojet quickshifter. Insert the wires from the Dynojet quickshifter into the SHIFTER inputs. The polarity of the wires is not important.

Speed-

If your application has a speed sensor then you can tap into the signal side of the sensor and run a wire into this input. This will allow you to calculate gear position in the Control Center Software. Once gear position is setup you can alter your map based on gear position and setup gear dependent kill times when using a quickshifter.

Analog-

This input is for a 0-5v signal such as engine temp, boost, etc. Once this input is established you can alter your fuel curve based on this input in the control center software.

Crank-

Do **NOT** connect anything to this port unless instructed to do so by Dynojet. It is used to transfer crank trigger data from one module to another.

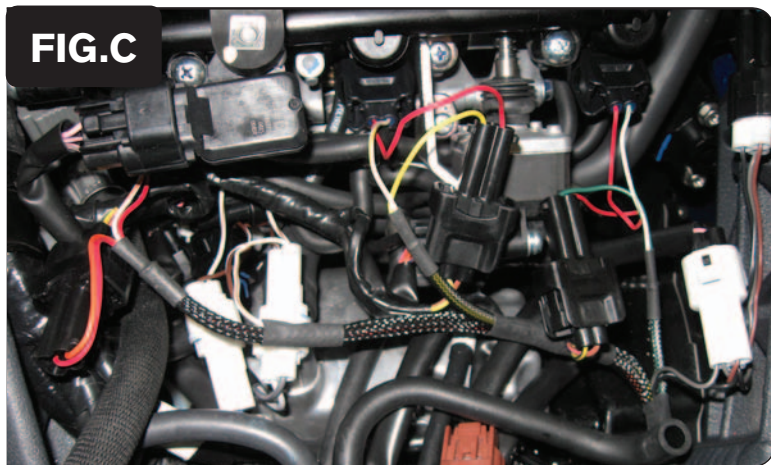
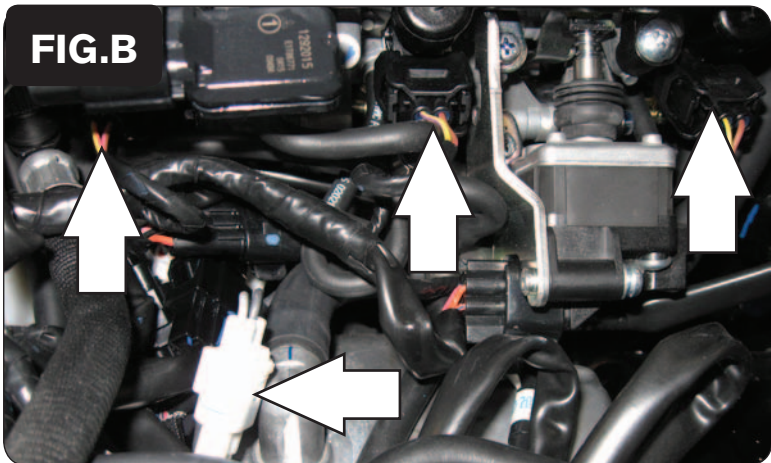
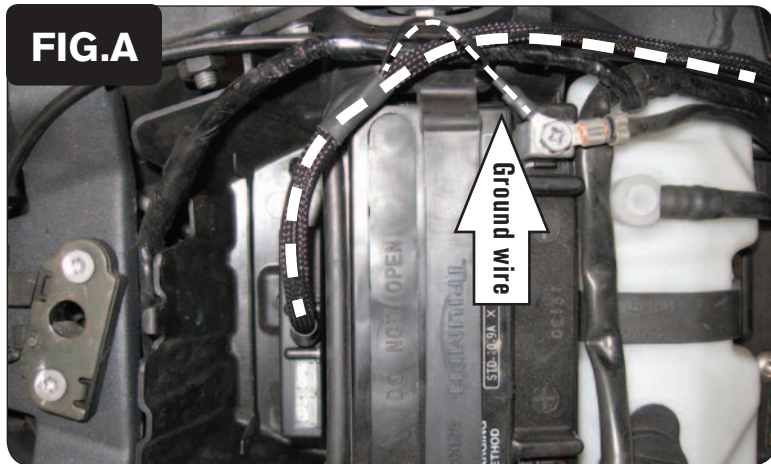

- 1 Remove the seat.
- 2 Remove the fuel tank
- 3 Secure the PCV to the rear of the battery (Fig. A).
- 4 Route the PCV harness to the left side of the battery and go towards the throttle bodies.
- 5 Attach the ground wire of the PCV to the negative side of the battery (Fig. A).

- 6 Unplug the stock wiring harness from each injector (Fig. B).
Squeeze the sides of the connector to remove.
- 7 Unplug the crank position sensor connector (Fig. B).
This is a WHITE 2 pin connector

- 8 Plug the PCV harness in-line of the stock wiring harness and each injector
PCV harness:
ORANGE - cylinder #1 (left)
YELLOW - cylinder #2
GREEN - cylinder #3



- 9 Plug the PCV harness in-line of the stock wiring harness and crank position sensor harness (Fig. D).

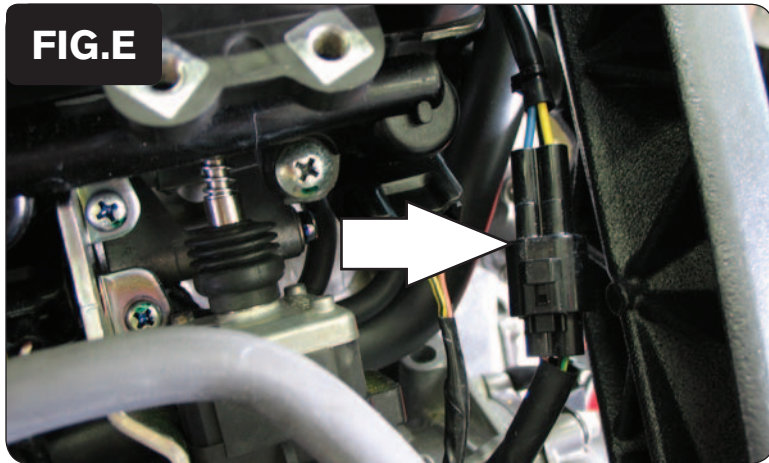

- 10 Locate the Throttle Position Sensor connector. Unplug this connector
This is a BLACK 3 pin connector located to the right of the throttle bodies.

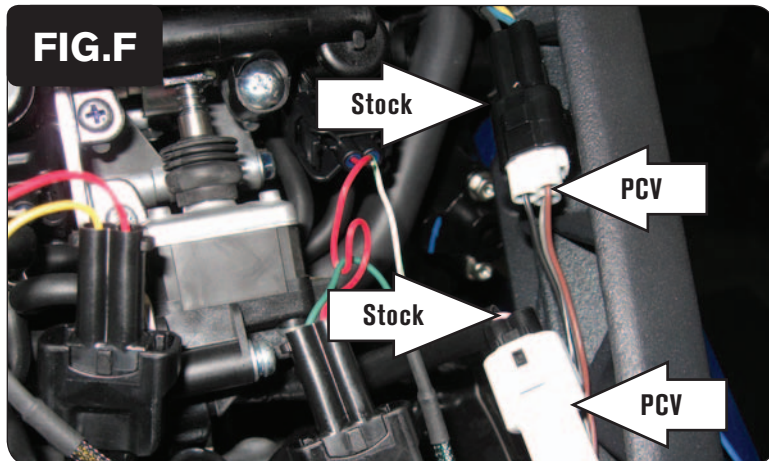

- 11 Plug the PCV harness in-line of the stock TPS connectors (Fig. F).

FIG.G

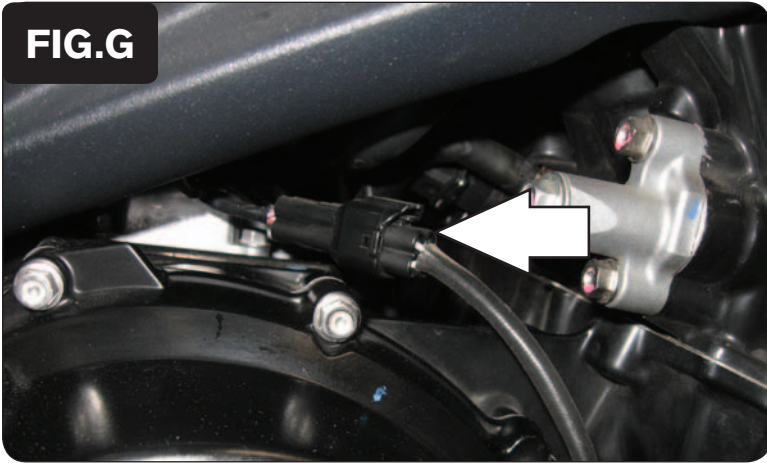

- 12 Disconnect the stock O2 sensor from the main wiring harness.
This is a BLACK 4 pin connector located near the cam chain tensioner.

FIG.H

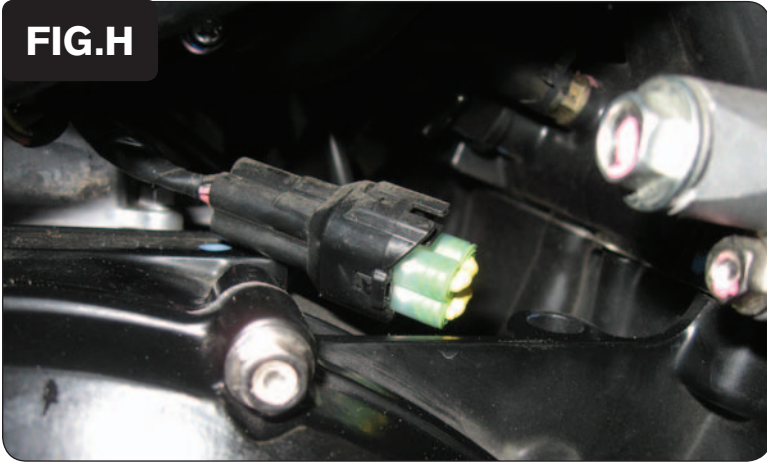

- 13 Connect the supplied O2 Optimizer to the stock wiring harness.
The stock O2 sensor will no longer be connected to anything.
- 14 Reinstall fuel tank and seat.