

[POWER COMMANDER V]

2010 Yamaha FZ1

Installation Instructions



Parts List

- 1 Power Commander
- 1 USB Cable
- 1 CD-ROM
- 1 Installation Guide
- 2 Power Commander Decals
- 2 Dynojet Decals
- 2 Velcro® Strip
- 1 Alcohol Swab
- 1 O2 optimizer

The ignition MUST be turned OFF before installation!

YOU CAN ALSO DOWNLOAD THE
POWER COMMANDER SOFTWARE AND
LATEST MAPS FROM OUR WEB SITE AT:
WWW.POWERCOMMANDER.COM

PLEASE READ ALL DIRECTIONS BEFORE STARTING INSTALLATION

Dynojet

2191 Mendenhall Drive North Las Vegas, NV 89081 (800) 992-4993 www.powercommander.com

POWER COMMANDER V INPUT ACCESSORY GUIDE

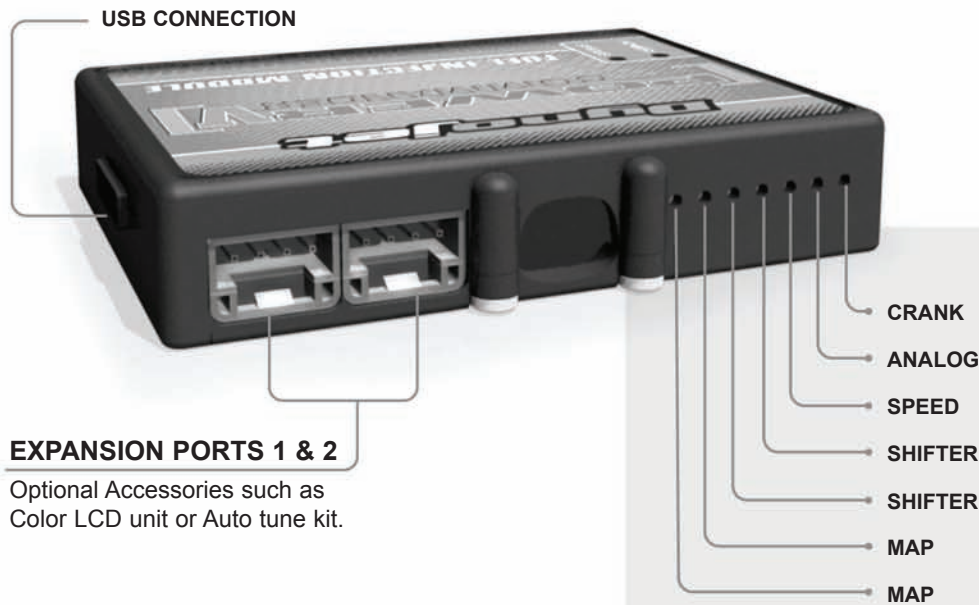

EXPANSION PORTS 1 & 2

Optional Accessories such as Color LCD unit or Auto tune kit.

Wire connections:

To input wires into the PCV first remove the rubber plug on the backside of the unit and loosen the screw for the corresponding input. Using a 22-24 gauge wire strip about 10mm from its end. Push the wire into the hole of the PCV until it stops and then tighten the screw. Make sure to reinstall the rubber plug.

NOTE: If you tin the wires with solder it will make inserting them easier.

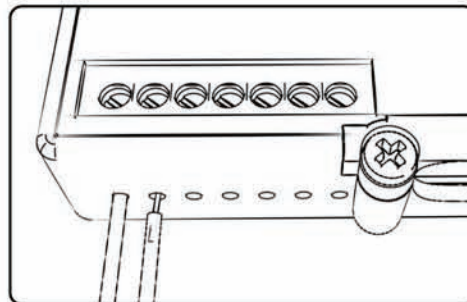

ACCESSORY INPUTS

- Map -** The PCV has the ability to hold 2 different base maps. You can switch on the fly between these two base maps when you hook up a switch to the MAP inputs. You can use any open/close type switch. The polarity of the wires is not important. When using the Autotune kit one position will hold a base map and the other position will let you activate the learning mode. When the switch is "CLOSED" Autotune will be activated.
- Shifter-** These inputs are for use with the Dynojet quickshifter. Insert the wires from the Dynojet quickshifter into the SHIFTER inputs. The polarity of the wires is not important.
- Speed-** If your application has a speed sensor then you can tap into the signal side of the sensor and run a wire into this input. This will allow you to calculate gear position in the Control Center Software. Once gear position is setup you can alter your map based on gear position and setup gear dependent kill times when using a quickshifter.
- Analog-** This input is for a 0-5v signal such as engine temp, boost, etc. Once this input is established you can alter your fuel curve based on this input in the control center software.
- Crank-** Do **NOT** connect anything to this port unless instructed to do so by Dynojet. It is used to transfer crank trigger data from one module to another.

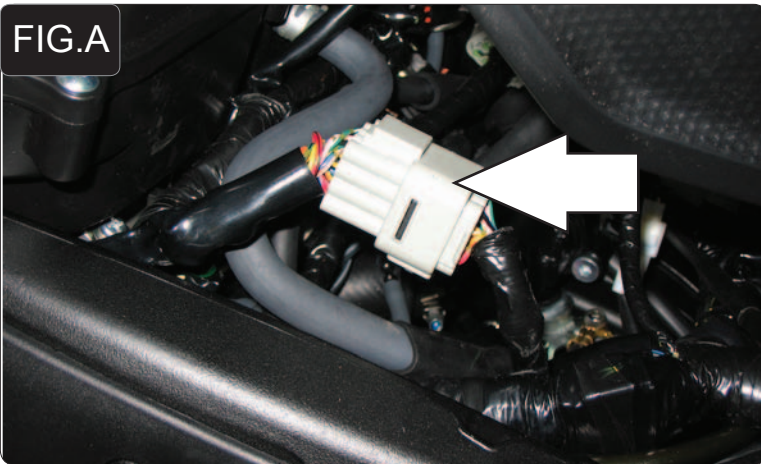

- 1 Remove the main seat and the passenger seat.
- 2 Prop the front of the fuel in the up position.
- 3 Lay the PCV in the tail section temporarily. Route the PCV harness under the tail section and go towards the front of the bike.
- 4 Locate the connector from the main wiring harness to the injector rail and uplug this connector (Fig. A).

NOTE: This connector is grey in color.



- 5 Plug the connectors from the PCV in-line of the stock wiring harness (Fig. B).

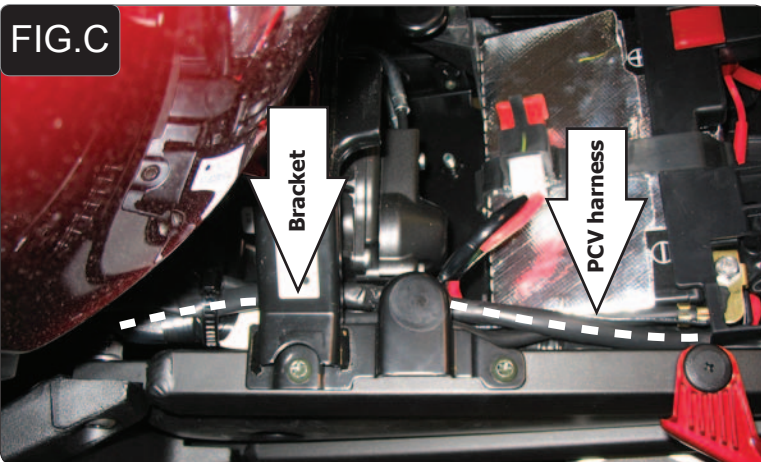

- 6 Remove the bolt on the left hand side of the fuel tank bracket and loosen the right hand bolt enough to route the PCV harness underneath it (Fig. C).
- 7 Re-tighten the bracket.

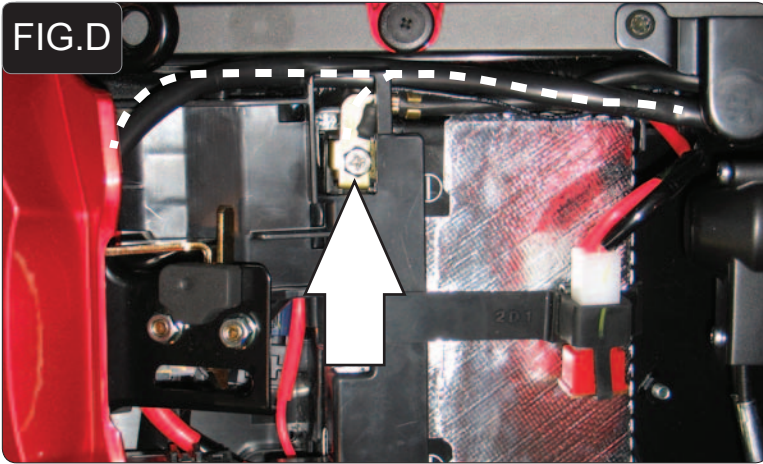

- 8 Attach the ground wire from the PCV to the negative side of the battery (Fig. D).

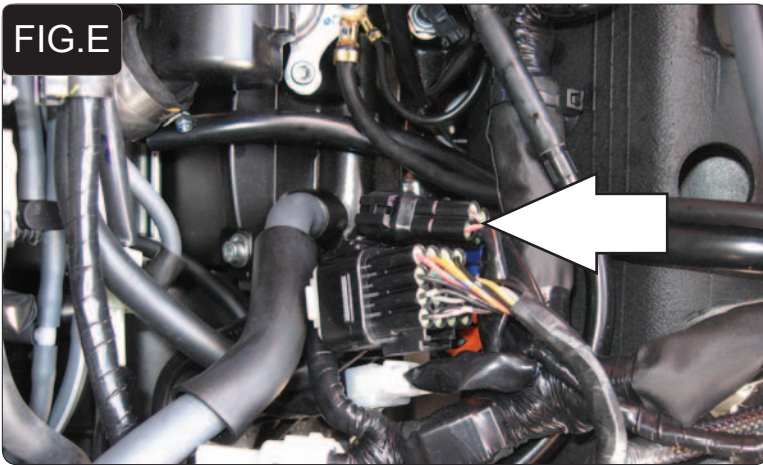

- 9 Locate the stock O2 sensor in the exhaust. Follow the O2 sensor harness and unplug it from the main wiring harness (Fig. E)..

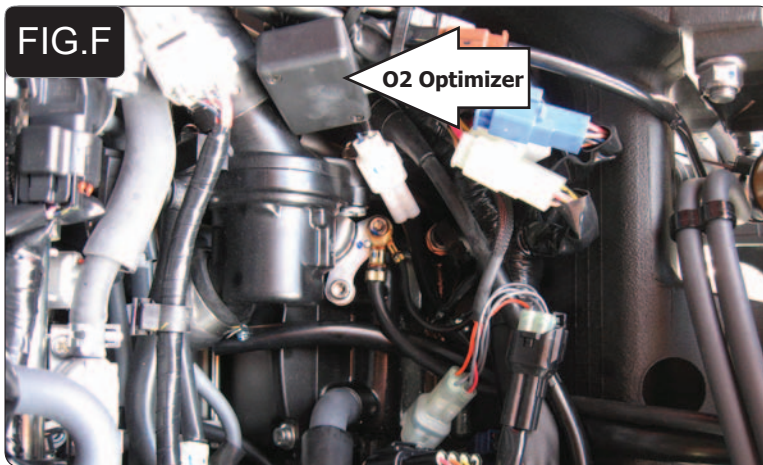

- 10 Plug the O2 Optimizer in-line of the stock O2 sensor and stock wiring harness.
- 11 Secure the Optimizer to the wiring harness using a zip tie (Fig. F).

FIG.G



- 12 Install the PCV in the rear section of the trunk (Fig. G).
- 13 Make sure all the wires are routed properly.
- 14 Reinstall the main seat and the passenger seat.

Speed input - Pink wire on white 3 pin connector under fuel tank

Temperature input - Green/White wire - same plug as PC

12v source for Auto tune - BLUE wire of tail light connector

	0	2	5	10	15	20	40	60	80	100
500	0	0	0	0	0	0	0	0	0	0
750	0	0	0	0	0	0	0	0	0	0
1000	0	0	0	0	0	0	0	0	0	0
1250	0	0	0	0	0	0	0	0	0	0
1500	0	0	0	0	0	0	0	0	0	0
1750	0	0	0	0	0	0	0	0	0	0
2000	0	0	0	0	0	0	0	0	0	0
2250	0	0	0	0	0	0	0	0	0	0
2500	0	0	0	0	0	0	0	0	0	0
2750	0	0	0	0	0	0	0	0	0	0
3000	0	0	0	0	0	0	0	0	0	0
3250	0	0	0	0	0	0	0	0	0	0
3500	0	0	0	0	0	0	0	0	0	0
3750	0	0	0	0	0	0	0	0	0	0
4000	0	0	0	0	0	0	0	0	0	0
4250	0	0	0	0	0	0	0	0	0	0
4500	0	0	0	0	0	0	0	0	0	0
4750	0	0	0	0	0	0	0	0	0	0
5000	0	0	0	0	0	0	0	0	0	0
5250	0	0	0	0	0	0	0	0	0	0
5500	0	0	0	0	0	0	0	0	0	0
5750	0	0	0	0	0	0	0	0	0	0
6000	0	0	0	0	0	0	0	0	0	0
6250	0	0	0	0	0	0	0	0	0	0
6500	0	0	0	0	0	0	0	0	0	0
6750	0	0	0	0	0	0	0	0	0	0
7000	0	0	0	0	0	0	0	0	0	0
7250	0	0	0	0	0	0	0	0	0	0
7500	0	0	0	0	0	0	0	0	0	0

The O2 optimizer for this model controls the stock closed loop area. This area is represented by the highlighted cells. The optimizer is designed to achieve a target AFR of 13.6:1. To use this optimizer you must retain your stock O2 sensor.

It is not necessary to alter the values in the highlighted area. If using the Auto tune system do NOT input values in this area in your Target AFR table.

The Optimizer will blink while the sensor is being heated up. The unit is not functioning until the light is lit up solid.